



FMB003

Easy OBDII tracker

Quick Manual v1.5

CONTENT

Know your device.....	3
Pinout	4
Set up your device	5
PC Connection (Windows).....	6
How to install USB drivers (Windows)	6
Configuration.....	7
Quick SMS configuration.....	9
Mounting recommendations.....	11
Basic characteristics	12
LED indications.....	12
Safety information	15
Certification and Approvals	16
Warranty	18
Warranty disclaimer	18

KNOW YOUR DEVICE

TOP VIEW

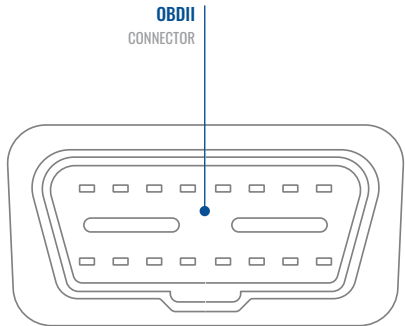

TOP VIEW (WITHOUT COVER)

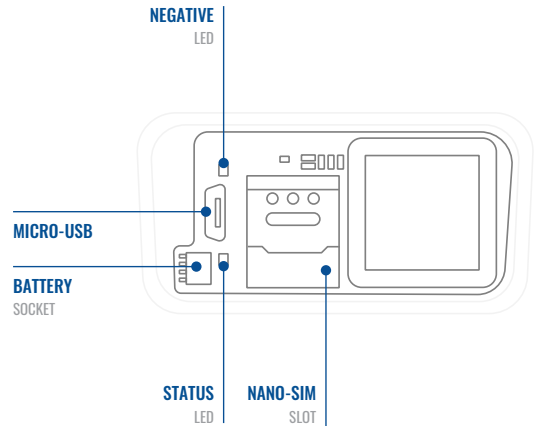

PINOUT

PIN NUMBER	PIN NAME	DESCRIPTION
2	PWM_BUS+/VPW	
4	GND (-)	Ground
5	GND (-)	Ground
6	CAN_H	CAN high
7	K-Line	
10	PWM_BUS-	
14	CAN_L	CAN low
15	L-Line	
16	VCC (10 - 30) V DC (+)	Power supply (+10 - 30 V DC)

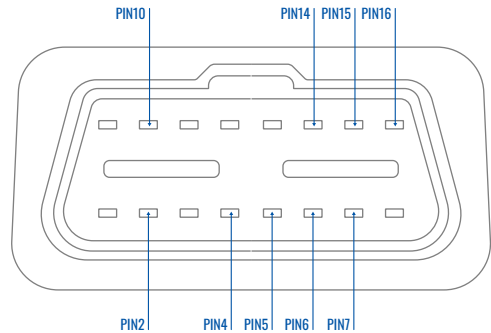

FMB003 OBDII socket pinout

SET UP YOUR DEVICE

HOW TO INSERT NANO-SIM CARD AND CONNECT THE BATTERY

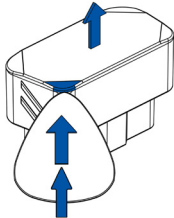

1 COVER REMOVAL

Open the top cover of the device. Cover is opened by unclipping it at the recessed corner.

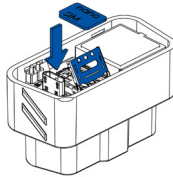

2 NANO-SIM CARD INSERT

Insert **Nano-SIM** card as shown with **PIN request disabled** or read our [Wiki¹](#) how to enter it later in [Teltonika Configurator²](#). Make sure that Nano-SIM card **cut-off corner** is pointing forward to slot.

¹ wiki.teltonika-gps.com/view/FMB003_Security_info

² wiki.teltonika.lt/view/Teltonika_Configurator

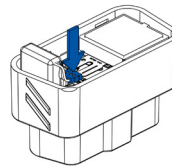

3 BATTERY CONNECTION

Connect **battery** as shown to device. Position the battery in place where it does not obstruct other components.

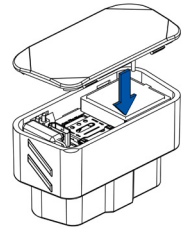

4 ATTACHING COVER BACK

Attach device **cover** back. Device is ready to be connected.

PC CONNECTION (WINDOWS)

1. Power-up FMB003 with **DC voltage (10 – 30 V)** power supply using **supplied power cable**. LED's should start blinking, see "**LED indications**".
2. Connect device to computer using **Micro-USB cable** or Bluetooth connection:
 - Using Micro-USB cable
 - You will need to install USB drivers, see "**How to install USB drivers (Windows)**"¹
 - Using **Bluetooth**
 - FMB003 **Bluetooth** is enabled by default. Turn on Bluetooth on your PC, then select **Add Bluetooth or other device > Bluetooth**. Choose your device named – "**FMBxxx_last_7_imei_digits**", without **LE** in the end. Enter default password **5555**, press **Connect** and then select **Done**.
3. You are now ready to use the device on your computer.

¹wiki.teltonika-gps.com/view/FMB003_LED_status

²Page 6, "How to install USB drivers"

HOW TO INSTALL USB DRIVERS (WINDOWS)

1. Please download COM port drivers from [here](#)¹.
2. Extract and run **TeltonikaCOMDriver.exe**.
3. Click **Next** in driver installation window.
4. In the following window click **Install** button.
5. Setup will continue installing the driver and eventually the confirmation window will appear. Click **Finish** to complete the setup.

¹teltonika-gps.com/downloads/en/fmb120/TeltonikaCOMDriver.zip

CONFIGURATION

At first FMB003 device will have default factory settings set. These settings should be changed according to the users needs. Main configuration can be performed via [Teltonika Configurator](#)¹ software. Get the latest **Configurator** version from [here](#)². Configurator operates on **Microsoft Windows OS** and uses prerequisite **MS .NET Framework**. Make sure you have the correct version installed.

¹ wiki.teltonika-gps.com/view/Teltonika_Configurator

² wiki.teltonika-gps.com/view/Teltonika_Configurator_versions

MS .NET REQUIREMENTS

Operating system	MS .NET Framework version	Version	Links
Windows Vista			
Windows 7			
Windows 8.1	MS .NET Framework 4.6.2	32 and 64 bit	www.microsoft.com ¹
Windows 10			

¹ dotnet.microsoft.com/en-us/download/dotnet-framework/net462

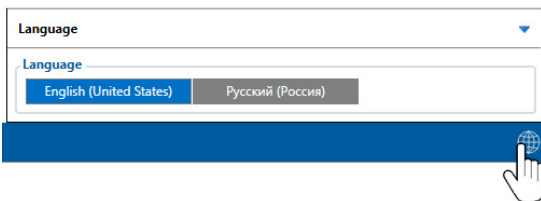

Downloaded Configurator will be in compressed archive. Extract it and launch Configurator.exe. After launch software language can be changed by clicking  in the right bottom corner.





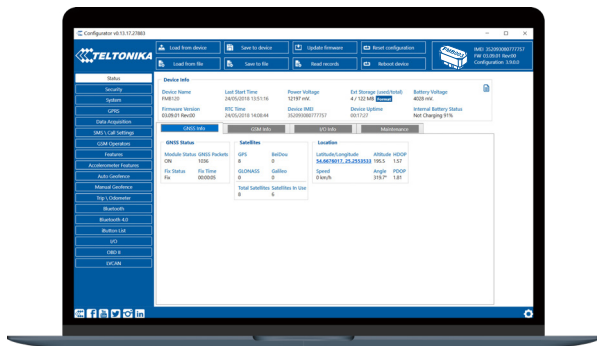





Configuration process begins by pressing on connected device.



After connection to Configurator **Status window** will be displayed.

Various **Status window**¹ tabs display information about **GNSS**², **GSM**³, **I/O**⁴, **Maintenance**⁵ and etc. FMB003 has one user editable profile, which can be loaded and saved to the device. After any modification of configuration the changes need to be saved to device using **Save to device** button. Main buttons offer following functionality:

-  **Load from device** – loads configuration from device.
-  **Save to device** – saves configuration to device.
-  **Load from file** – loads configuration from file.
-  **Save to file** – saves configuration to file.
-  **Update firmware** – updates firmware on device.
-  **Read records** – reads records from the device.
-  **Reboot device** – restarts device.
-  **Reset configuration** – sets device configuration to default.

Most important configurator section is **GPRS** – where all your server and **GPRS settings**⁶ can be configured and **Data Acquisition**⁷ – where data acquiring parameters can be configured. More details about FMB003 configuration using Configurator can be found in our **Wiki**⁸.

¹ wiki.teltonika-gps.com/view/FMB003_Status_info

² wiki.teltonika-gps.com/view/FMB003_Status_info#GNSS_Info

³ wiki.teltonika-gps.com/view/FMB003_Status_info#GSM_Info

⁴ [wiki.teltonika-gps.com/view/FMB003_Status_info#I.2FO_Info](https://wiki.teltonika-gps.com/view/FMB003_Status_info#I2FO_Info)

⁵ wiki.teltonika-gps.com/view/FMB003_Status_info#Maintenance

⁶ wiki.teltonika-gps.com/index.php?title=FMB003_GPRS_settings

⁷ wiki.teltonika-gps.com/index.php?title=FMB003_Data_acquisition_settings

⁸ wiki.teltonika-gps.com/index.php?title=FMB003_Configuration

QUICK SMS CONFIGURATION

Default configuration has optimal parameters present to ensure best performance of track quality and data usage.

Quickly set up your device by sending this SMS command to it:

```
« setparam 2001:APN;2002:APN_username;2003:APN_password;2004:Domain;2005:Port;2006:0»
```

1

2

3

4

5

6

Note: Before SMS text, two space symbols should be inserted.

GPRS SETTINGS:

- 1 2001 – APN
- 2 2002 – APN username (if there are no APN username, empty field should be left)
- 3 2003 – APN password (if there are no APN password, empty field should be left)

SERVER SETTINGS:

- 4 2004 – Domain
- 5 2005 – Port
- 6 2006 – Data sending protocol (0 – TCP, 1 – UDP)

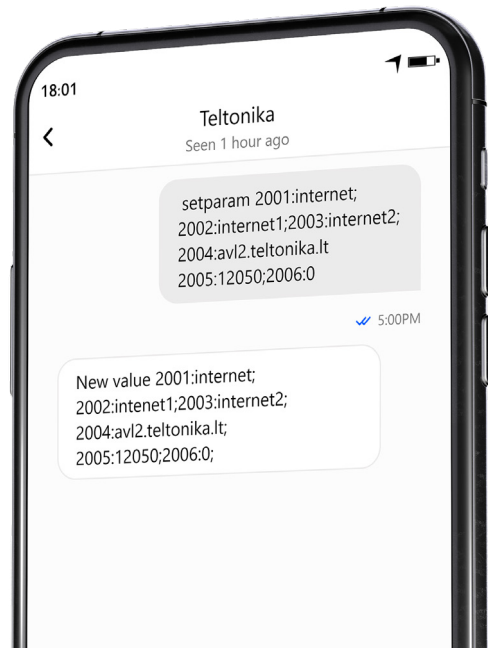

DEFAULT CONFIGURATION SETTINGS

MOVEMENT AND IGNITION DETECTION:



VEHICLE MOVEMENT
will be detected by
accelerometer



IGNITION
will be detected by
vehicle power voltage
between 13,2 – 30 V

DEVICE MAKES A RECORD ON STOP IF:



1 HOUR PASSES
while vehicle is
stationary and
ignition is off



EVERY 120 SECOND
it is sent to the server
If device has made a
record

DEVICE MAKES A RECORD ON MOVING IF ONE OF THESE EVENTS HAPPEN:



PASSES
300 seconds



VEHICLE DRIVES
100 meters



VEHICLE TURNS
10 degrees



SPEED DIFFERENCE
between last coordinate
and current position is
greater than 10 km/h

After successful SMS configuration, FMB003 device will synchronize time and update records to configured server. Time intervals and default I/O elements can be changed by using [Teltonika Configurator¹](#) or [SMS parameters²](#).

¹ wiki.teltonika-gps.com/view/Teltonika_Configurator

² wiki.teltonika-gps.com/view/Template:FMB_Device_Family_Parameter_list

MOUNTING RECOMMENDATIONS

CONNECTING THE DEVICE TO THE VEHICLE:

Find OBDII connector in your vehicle.

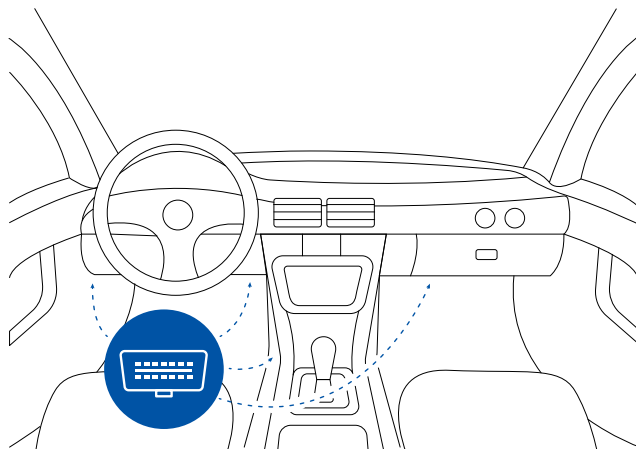

Most common OBDII connector locations.

LED INDICATIONS

NAVIGATION LED INDICATIONS

BEHAVIOUR	MEANING
Permanently switched on	GNSS signal is not received
Blinking every second	Normal mode, GNSS is working
Off	GNSS is turned off because: Device is not working or Device is in sleep mode
Blinking fast constantly	Device firmware is being flashed

STATUS LED INDICATIONS

BEHAVIOUR	MEANING
Blinking every second	Normal mode
Blinking every two seconds	Sleep mode
Blinking fast for a short time	Modem activity
Off	Device is not working or Device is in boot mode

BASIC CHARACTERISTICS

MODULE

Name	Teltonika TM2500
Technology	GSM/GPRS/GNSS/BLUETOOTH

GNSS

GNSS	GPS, GLONASS, GALILEO, BEIDOU, SBAS, QZSS, DGPS, AGPS
Receiver	33 channel
Tracking sensitivity	-165 dBm
Accuracy	< 3 m
Hot start	< 1 s
Warm start	< 25 s
Cold start	< 35 s

CELLUAR

Technology	GSM
2G bands	Quad-band 850 / 900 / 1800 / 1900 MHz

Maximum output power	GSM 900: 33dBm±2dB (Rated conducted) GSM 1800: 30dBm±2dB (Rated conducted) Bluetooth: 5.22 dBm (Maximum out EIRP) Bluetooth LE: -9.43 dBm (Maximum out EIRP)
----------------------	---

Data transfer	GPRS Multi-Slot Class 12 (up to 240 kbps)
---------------	---

Data support	SMS (text/data)
--------------	-----------------

POWER

Input voltage range	10 - 30 V DC with overvoltage protection
---------------------	--

Back-up battery	3.7 V 45 mAh
-----------------	--------------

Power Consumption	At 12V < 5 mA (Ultra Deep Sleep)
	At 12V < 7 mA (Deep Sleep)
	At 12V < 7 mA (Online Deep Sleep)
	At 12V < 8 mA (GPS Sleep)
Power Consumption	At 12V < 8 mA (GPS Sleep)
	At 12V < 28 mA (nominal with no load)

Internal fuse	3A, 125V
---------------	----------

BLUETOOTH

Specification	4.0 + LE
---------------	----------

Supported peripherals

Temperature and Humidity sensor¹, Headset² Inateck Barcode Scanner, Universal BLE sensor support

OBD INTERFACE

Data	K-Line, CAN Bus data
------	----------------------

Data reading	Up to 32 vehicle onboard parameters: SAE J1850 PWM (41.6 kbaud) SAE J1850 VPW (10.4 kbaud) ISO 9141-2 (5 baud init, 10.4 kbaud) ISO 14230-4 KWP (5 baud init, 10.4 kbaud) ISO 14230-4 KWP (fast init, 10.4 kbaud) ISO 15765-4 CAN (11 bit ID, 250 kbaud) ISO 15765-4 CAN (11 bit ID, 500 kbaud) ISO 15765-4 CAN (29 bit ID, 250 kbaud) ISO 15765-4 CAN (29 bit ID, 500 kbaud)
--------------	--

¹ teltonika.lt/product/bluetooth-sensor/

² wiki.teltonika.lt/view/How_to_connect_Blue-tooth_Hands_Free_adapter_to_FMB_device

INTERFACE

Connection	OBDII socket
GNSS antenna	Internal High Gain
GSM antenna	Internal High Gain
USB	2.0 Micro-USB
LED indication	2 status LED lights
SIM	Nano-SIM
Memory	128MB internal flash memory

PHYSICAL SPECIFICATION

Dimensions	52.6 x 29.1 x 26 mm (L x W x H)
------------	---------------------------------

OPERATING ENVIRONMENT

Operating temperature (without battery)	-40 °C to +85 °C
Storage temperature (without battery)	-40 °C to +85 °C
Operating humidity	5% to 95% non-condensing
Battery charge temperature	+10 °C to +45 °C
Battery discharge temperature	-20 °C to +60 °C
Battery storage temperature	-20 °C to +45 °C for 1 month -20 °C to +35 °C for 6 months

FEATURES

Sensors	Accelerometer
Scenarios	Green Driving, Over Speeding detection, Jamming detection, GNSS Fuel Counter, Excessive Idling detection, Unplug detection, Towing detection, Crash detection, Auto Geofence, Manual Geofence, Trip³
Sleep modes	GPS Sleep, Online Deep Sleep, Deep Sleep, Ultra Deep Sleep⁴
Configuration and firmware update	FOTA Web⁵, FOTA⁶, Teltonika Configurator⁷ (USB, Bluetooth), FMBT mobile application⁸ (Configuration)
SMS	Configuration, Events, Debug
GPRS commands	Configuration, Debug
Time Synchronization	GPS, NITZ, NTP
Fuel monitoring	OBDII
Ignition detection	Accelerometer, External Power Voltage, Engine RPM

³wiki.teltonika-gps.com/view/FMB003_Features_settings

⁴wiki.teltonika-gps.com/view/FMB003_Sleep_modes#Deep_Sleep_mode

⁵wiki.teltonika-gps.com/view/FOTA_WEB

⁶wiki.teltonika-gps.com/view/FOTA

⁷wiki.teltonika-gps.com/view/Teltonika_Configurator

⁸wiki.teltonika-gps.com/view/FMBT_Mobile_application

SAFETY INFORMATION

This message contains information on how to operate FMB003 safely. By following these requirements and recommendations, you will avoid dangerous situations. You must read these instructions carefully and follow them strictly before operating the device!

- The device uses SELV limited power source. The nominal voltage is +12 V DC. The allowed voltage range is +10...+30 V DC.
- To avoid mechanical damage, it is advised to transport the device in an impact-proof package. Before usage, the device should be placed so that its LED indicators are visible. They show the status of device operation.
- Before unmounting the device from vehicle, ignition **MUST be OFF**.



Do not disassemble the device. If the device is damaged, the power supply cables are not isolated or the isolation is damaged, **DO NOT** touch the device before unplugging the power supply.



All wireless data transferring devices produce interference that may affect other devices which are placed nearby.



Please consult representatives of your vehicle model regarding OBDII location on your vehicle. In case you are not sure about proper connection, please consult qualified personnel.



The programming must be performed using a PC with autonomic power supply.



Installation and/or handling during a lightning storm is prohibited.



The device is susceptible to water and humidity.



Teltonika is not responsible for any harm caused by wrong cables used for connection between PC and FMB003



WARNING! Do not use FMB003 device if it distracts driver or causes inconvenience due to OBDII placement. Device must not interfere with driver.



Battery should not be disposed of with general household waste. Bring damaged or worn-out batteries to your local recycling center or dispose them to battery recycle bin found in stores.

CERTIFICATION AND APPROVALS



This sign on the package means that it is necessary to read the User's Manual before you start using the device. Full User's Manual version can be found in our [Wiki](#)¹.

¹ wiki.teltonika-gps.com/index.php?title=FMB003



Hereby, Teltonika declare under our sole responsibility that the above described product is in conformity with the relevant Community harmonization: European Directive 2014/53/EU (RED).



UK Conformity Assessed (UKCA) marking is a conformity mark that indicates conformity with the applicable requirements for above described products sold within Great Britain.



The RoHS1 is a directive regulating the manufacture, import and distribution of Electronics and Electrical Equipment (EEE) within the EU, which bans from use 10 different hazardous materials (to date).



REACH addresses the production and use of chemical substances, and their potential impacts on both human health and the environment. Its 849 pages took seven years to pass, and it has been described as the most complex legislation in the Union's history and the most important in 20 years. It is the strictest law to date regulating chemical substances and will affect industries throughout the world.



SIRIM QAS International Sdn. Bhd. is Malaysia's leading testing, inspection and certification body.



This sign on the package means that all used electronic and electric equipment should not be mixed with general household waste.



The Declaration EAC and the Certificate EAC in conformity with the technical regulation TR CU of the EurAsEC Customs Union are EAC certification documents issued by independent organizations. Such organizations perform their function through laboratories accredited to the public agencies in charge of the supervision of metrology and standardization in the three countries of the EAC Custom Union, joining at the moment the certification system : Russia, Belarus, Kazakhstan, Armenia and Kyrgyzstan.



E-Mark and e-Mark are the European conformity marks issued by the transport sector, indicating that the products comply with relevant laws and regulations or directives. Vehicles and related products need to go through the E-Mark certification process to be legally sold in Europe.

DECLARATION OF IMEI ASSIGNMENT

The IMEI number is used by a GSM network to identify valid devices and therefore can be used for stopping a stolen phone from accessing that network. For example, if a mobile phone is stolen, the owner can call their network provider and instruct them to blacklist the phone using its IMEI number. This renders the phone useless on that network and sometimes other networks too, whether or not the phone's subscriber identity module (SIM) is changed.



00647-20-08591

For more information, see the ANATEL website www.anatel.gov.br
This equipment is not entitled to protection against harmful interference and must not cause interference in duly authorized systems.



SDPPI (Direktur Jenderal Sumber Daya dan Perangkat Pos dan informatika) is Indonesian Directorate General of Resources and Equipment for Post and Information Technology.

CHECK ALL CERTIFICATES

All newest certificates may be found in our [Wiki](#)².

² wiki.teltonika-gps.com/view/FMB003_Certification_%26_Approvals

WARRANTY

We guarantee our products 24-month warranty¹ period.

All batteries carry a 6-month warranty period.

Post-warranty repair service for products is not provided.

If a product stops operating within this specific warranty time, the product can be:

- Repaired
- Replaced with a new product
- Replaced with an equivalent repaired product fulfilling the same functionality
- Replaced with a different product fulfilling the same functionality in case of EOL for the original product

¹ Additional agreement for an extended warranty period can be agreed upon separately.

WARRANTY DISCLAIMER

- Customers are only allowed to return products as a result of the product being defective, due to order assembly or manufacturing fault.
- Products are intended to be used by personnel with training and experience.
- Warranty does not cover defects or malfunctions caused by accidents, misuse, abuse, catastrophes, improper maintenance or inadequate installation – not following operating instructions (including failure to heed warnings) or use with equipment with which it is not intended to be used.
- Warranty does not apply to any consequential damages.
- Warranty is not applicable for supplementary product equipment (i. e. PSU, power cables, antennas) unless the accessory is defective on arrival.
- [More information on what is RMA¹](#)

¹ wiki.teltonika-gps.com/view/RMA_guidelines